

The Everlast logo is displayed in white on a red square background. It features the word "EVERLAST" in a bold, serif font, with a stylized "E" logo underneath.

**HIGH
INTENSITY
TRAINING**

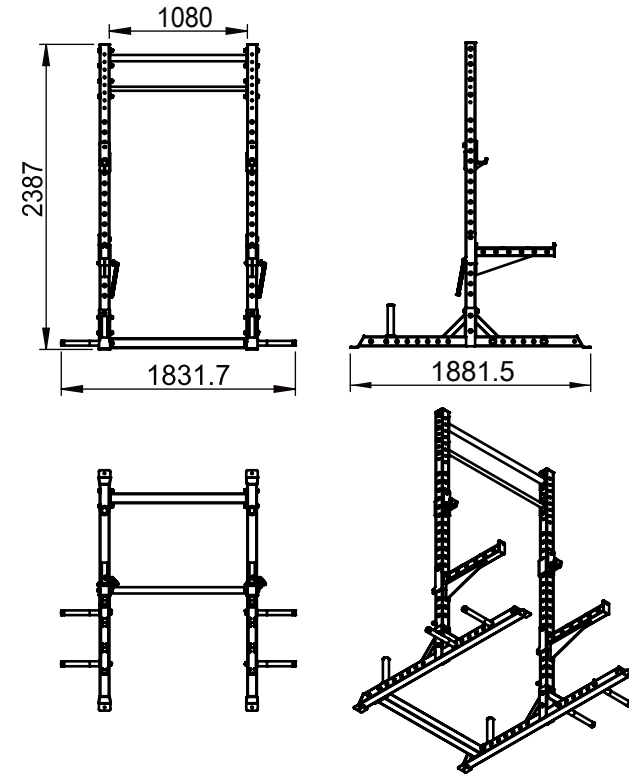



HALF RACK

SKU: EVHROW803 COLOR: Black / Yellow

Heavy duty square steel frame construction with H-Shape base for max stability and safety. Two pull up bars at different diameters are included. Mount at your preferred height. Two heavy duty J-Hooks are included too. Two spotter arms or dip bars with safety locker are included. Extra short bars can be used in many exercise types you preferred. Two weight plate holders are designed for convenience and enhanced stability.

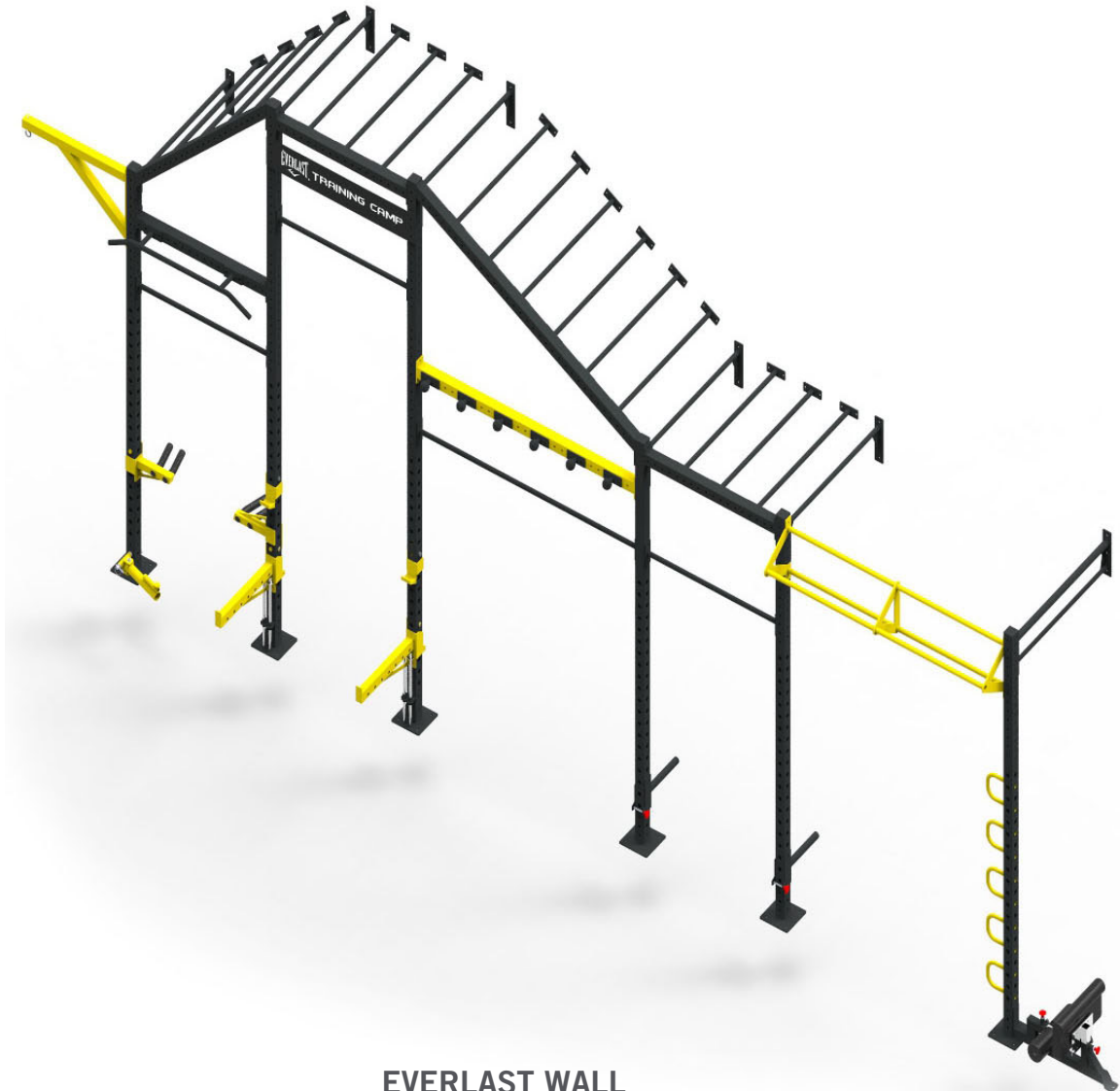
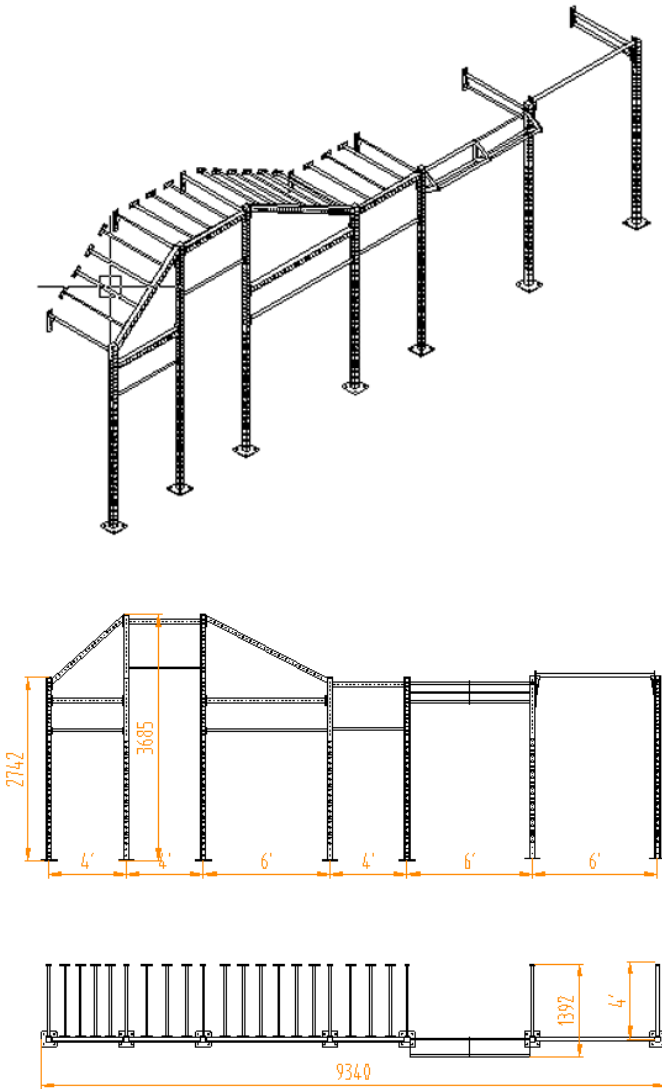

EVERLAST WALL TRAINING STRUCTURE

SKU: EV4TSR100 COLOR: Black / Yellow

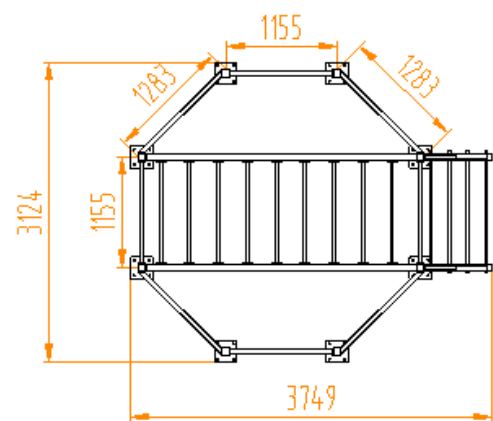
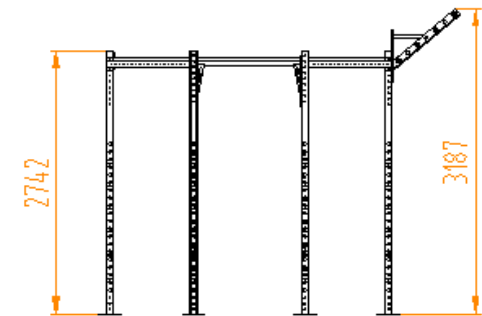
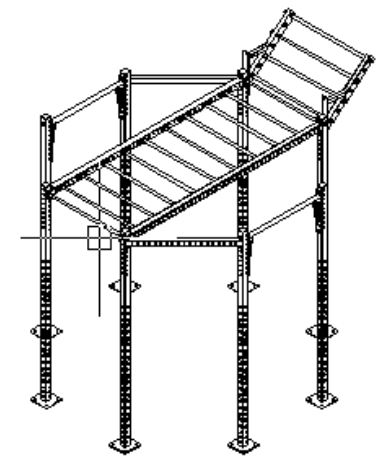

EVERLAST HEXAGONAL TRAINING STRUCTURE

SKU: EV4TSR600 COLOR: Black / Yellow



WALL MOUNTED DIP

(56.5cm x 64cm x 30cm)

Expand your weight room by using the everlast all mounted dip station. Increase the strength of your chest, shoulders And triceps. Once your workout is complete, Return the mount to its space saving position.

SKU: EVWD5R120 **COLOR:** Black

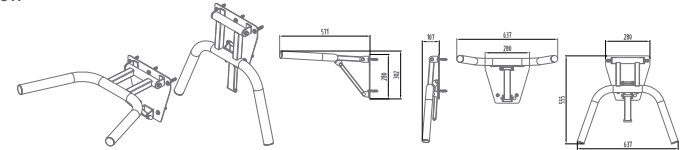

CHIN UP BAR

Easy assembly & installation
Holds up to 140kgs
Made from high quality steel
Mounts on to any solid wall
Offers a variety of grip positions & exercises

HOLDS UP TO
140
kgs

Structure 131cm X 58cm X 60cm

SKU: EVCH4R207 **COLOR:** Black

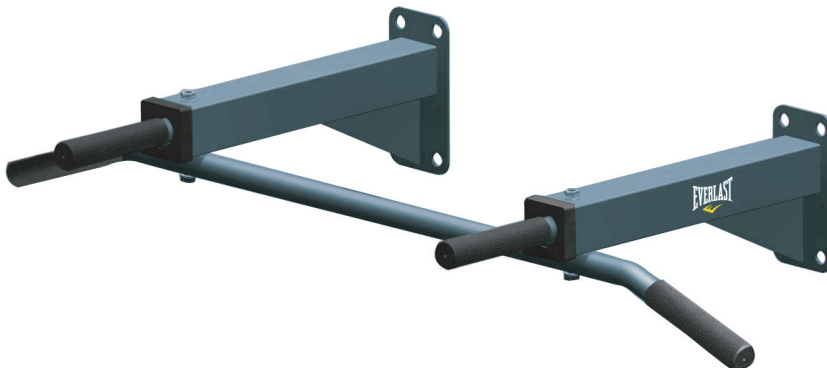

CHIN UP BAR

Easy assembly & installation
Made from high quality steel
Mounts on to any solid wall
Offers a variety of grip positions & exercises

ENGINEERED FOR:
TOTAL BODY CONDITIONING
STRENGTH TRAINING
INTENSE CARDIOVASCULAR WORKOUTS

HOLDS UP TO
140
kgs

Structure 100cm x 18cm

SKU: EVCH9W450 **COLOR:** Grey / Black



ADJUSTABLE POWER BRACKETS

PERFECT FOR BEGINNERS & ADVANCED
Improve strength and cardio, for all skill levels, secure grip.

Material ensures a secure grip during use.
Perfect fitness tool used to improve strength and cardio fitness.
Easily adjustable iron bracket can be modified according to exercise and skill level from 22" to 30"
Specially designed to be used as hurdles or for dips, pushups, inverted rows and more.

EVERGRIP

SKU: EVPB5S65 COLOR: Black / Lime



PUSHUPS

DIPS

INVERTED ROWS





SUSPENSION SYSTEM DELUXE

NEW

LETS YOU USE YOUR BODYWEIGHT WITH THE NATURAL FORCE OF GRAVITY.

Total-body workout system you can set up in less than 60 seconds at home or anywhere you go. Get stronger, build muscle, lose weight and improve flexibility fast no weights required.

Work out total body, burn fat and tone all lean muscles this trainer is a complete bodyweight gym that supports highly metabolic compound exercises and assisted exercise variations for full workouts for every skill level.

Increase muscle endurance & sport performance infinitely variable resistance. Full body resistance trainers feature indexed straps and quick adjust buckles so you can tailor resistance for each exercise.

SKU: EVST9W008 **COLOR:** Black / Red



ANTI-SLIP
FOAM RUBBER HANDLE



HEAVY DUTY
ZINC-ALLOY CARABINER



ADJUSTABLE
EASY TO SET BUCKLE



SUPER STURDY
DOOR ANCHOR

PACKAGE INCLUDED:
TWO BODYWEIGHT RESISTANCE STRAPS
ONE EXTENSION STRAP
ONE CARRY POUCH
ONE USER MAMUAL
ONE DOOR ANCHOR



WOOD GYM RINGS

Perfect for multiple exercises such as: Push-ups, iron cross, dips, muscle ups, pull-ups and many more.

Each set contains two rings and two numbered straps.

Superior feel of natural wood for a secure grip, even without chalk

Sold in sets of 2

Diameter: 1.25" standard

Firm grip with or without chalk

Includes (2) 1.5" Heavy Duty Black Nylon Straps with Buckle*

18' Strap long straps, 25mm wide strap

SKU: EVGROW125



POWER ROPE

ENGINEERED FOR: TOTAL BODY CONDITIONING, STRENGTH, CARDIOVASCULAR TRAINING, IMPROVED GRIP STRENGTH

30' Rope, 1.5" Diameter.

Durable synthetic blend with contoured handles.

ENGINEERED FOR:

- Total body conditioning
- Strength training
- Intense cardiovascular workouts

SKU: EVBR9W623 **COLOR:** BLACK

SIZE: BATTLE ROPE 38mm x 15m



CLIMBING/UTILITY ROPE WITH ANCHOR

Climbing ropes have always been one of the most popular and standard equipment requests for overall improvement of physical fitness and muscle tone, particularly for upper arms and shoulders.

Extremely popular training apparatus for strength, grip and arm coordination skills for use in physical education, wrestling, gymnastics, military, and cross-fit applications. Landing mats, spotting and supervision suggested when using.

SIZE:SKU: EVCR4R380 **SIZE:** 38mm /length: 15m

SKU: EVCR4R500 **SIZE:** 50mm /length: 15m



DELUXE SPEED ROPE

ADJUSTABLE ROPE UP TO 11 FT (3.35m)
Suitable for everyone - best jump rope for any workout, mastering double unders, exercise and fitness, mma training, boxing, bodybuilding, personal training, home and outdoor workouts.

SKU: EVSJ6S356
COLOR: Black / Lime



9' FEET LEATHER JUMP ROPE

High durability and speed
High quality precision ball bearings
Comfortable and smooth handling

SKU: EVLR8800
COLOR: Leather



EVERGRIP™ WEIGHTED JUMP ROPE

ENGINEERED FOR: SPEED, ENDURANCE, AGILITY, COORDINATION, TOTAL BODY CONDITIONING
Adjustable length, 9 ft. plastic speed rope.
Evergrip™ Handles provide added grip while training.
Removable weights to challenge your cardio and upper body training.
1.5 Lbs. Maximum Removable Weights Precision Ball Bearing
Rotation For Increased Speed.

SKU: 4485
COLOR: Black

EVERGRIP™



PLYOMETRIC WOODEN BOX

Our 3-in-1 power box is a staple item of any fitness studio or crossfit box. Simply rotate the wooden box to your desired height and jump.

This item is cnc machine cut with rounded edges and pre drilled screws makes this box a very fast to install.

Plyometric exercises are perfect to improve an athletes ability and skill and will seriously increase speed and strength.

SKU: EVBX8R243 **SIZE:** 20" x 24" x 30"

H.I.T. HIGH INTENSITY TRAINING



- **SKU: EVPB4R012**
MINI POWER BAND offers 5lbs - 35lbs
Resistance length - 102cm width - 12mm color:red
- **SKU: EVPB4R022**
XSMALL POWER BAND offers 10lbs - 50lbs
Resistance length -102cm width - 22mm color:purple
- **SKU: EVPB4R032**
SMALL POWER BAND provides 25lbs - 80lbs
Resistance length -102cm width - 32mm color:orange
- **SKU: EVPB4R044**
MEDIUM POWER BAND gives 50lbs - 120lbs
Resistance length -102cm width - 44mm color:blue
- **SKU: EVPB4R065**
LARGE POWER BAND offers 60lbs - 150lbs
Resistance length -102cm width - 65mm color:black

POWERBAND

Thick, extra strong and ideal for heavy use.

Designed to work lower leg muscles, provide resistance for walks, shuffles and lunges and help to prevent and rehabilitate sprained ankles.

Perfect for power assisted pull-ups/chin-ups, as well as in all fitness activities to provide added resistance to your workout.

Allows the user to customize and create a level of resistance that fits their strength level by controlling the tension in the resistance by shortening or lengthening the band.





LOOP BANDS (3pk)

3-piece resistance bands give you a variety of resistance levels. Light, medium and heavy loops let you adjust the intensity of your workouts to challenge every major muscle group in your body.

3
LEVELS OF
RESISTANCE

SKU: EVMB71630 **COLOR:** Black / Grey / Yellow

ENGINEERED FOR:
RESISTANCE TRAINING, WARM UP AND
REHABILITATION OF UPPER AND LOWER BODY.



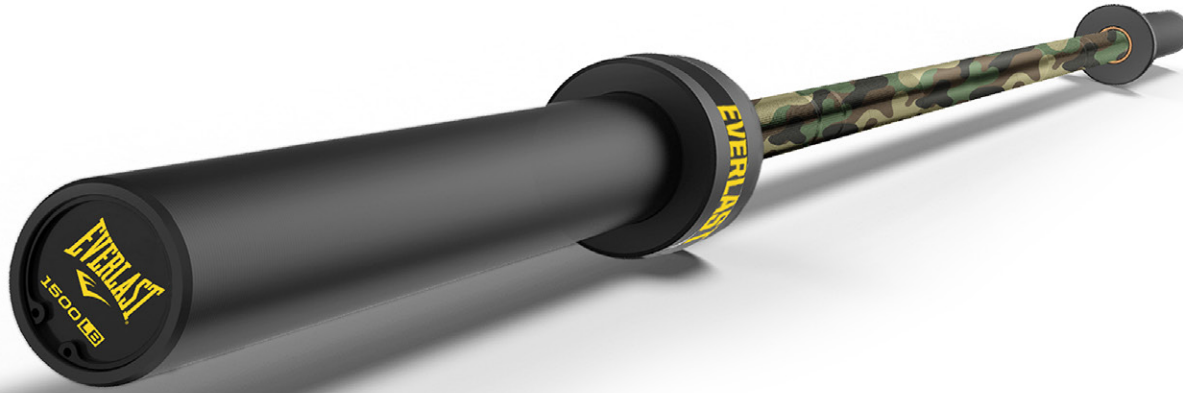

**Men's Bars
1500 LB**

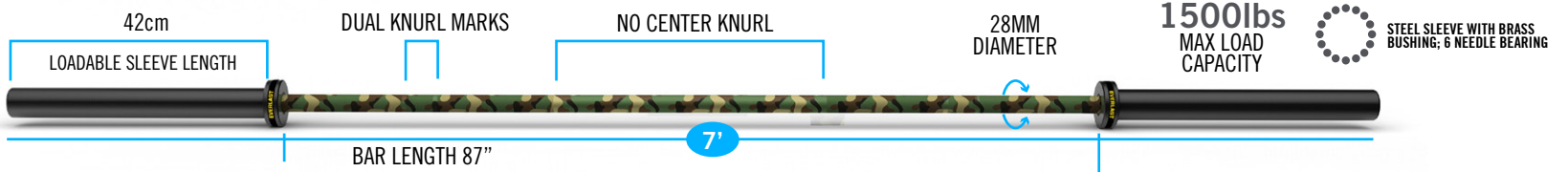

**Women's Bars
1000 LB**



28mm CROSS FIT BARS, 7'
25mm CROSS FIT BARS, 6'

Brass bushings for reliable spin and satisfactory whip
Knurling marks for both olympic and power lifting Bar collars are snap ring design
Bearings allow the hard chrome sleeves to rotate freely promoting a smoother, quieter spin.
Material :Alloy Steel with heat treatment

SKU: EVOBOR186 (1500 LB) WEIGHTLIFTING BAR, 7'
SKU: EVOBOR115 (1000 LB) WEIGHTLIFTING BAR, 6'



LOCKS NOT INCLUDED
SKU: EVOCR100

H.I.T. HIGH INTENSITY TRAINING



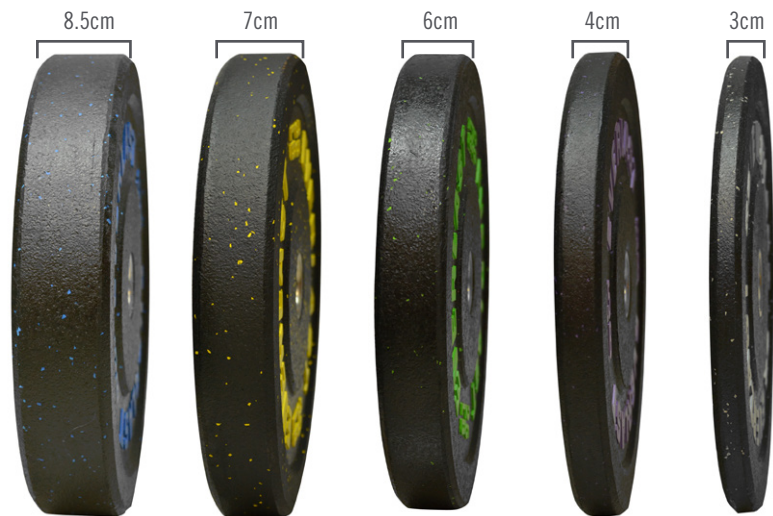

HI-IMPACT BUMPER PLATES

DIAMETER: 45cms

Heavy-duty bumper plates designed to resist the heaviest of workouts.

Made of recycled crumb rubber.

Drop test: 2m x 8000 repetitions.

Steel rim bushing.

SKU: EVBP8R010 10LB COLOR: Grey

SKU: EVBP8R015 15LB COLOR: Pink

SKU: EVBP8R025 25LB COLOR: Green

SKU: EVBP8R035 35LB COLOR: Yellow

SKU: EVBP8R045 45LB COLOR: Blue





ARM BLASTER

PRODUCT DIMENSIONS: 23" L X 4" H, PRODUCT WEIGHT: 1KG ONE SIZE FITS ALL.
Uniquely contoured rigid metal design allows you to isolate your arms and shoulders.
Webbed nylon belt, a thick, oversized neoprene neck pad, and dense elbow pads.
The strap features a quick release to adjust it to the perfect position.
Bulk up your biceps each time you grab a workout Bar with the bicep bomber.

NEW

SKU: EVAR9H200 COLOR: Black

CURVED BODY DESIGN

The perfectly contoured shape conforms around your torso and cradles your triceps.

HEAVY DUTY CONSTRUCTION

The arm blaster body is constructed from tough gauge aluminum for a high-level workout.

SUPERIOR NECK SUPPORT

The elite neck strap is constructed from supreme foam padding for a pain-free experience.

COMFORT PADDED ENDS

The dual padded design supports your triceps and allows you to perform max reps in comfort.

INTUITIVE STRAP TECHNOLOGY

The strap features a quick release mechanism for easy adjustment into the ideal position.

ENGINEERED FOR:

TENSION
MOTION
STRENGTH

Our Arm Blaster for biceps is the ideal tool for weight lifting and body building. The blaster body supports your elbows, enabling you to keep correct posture during curls and triceps exercises.

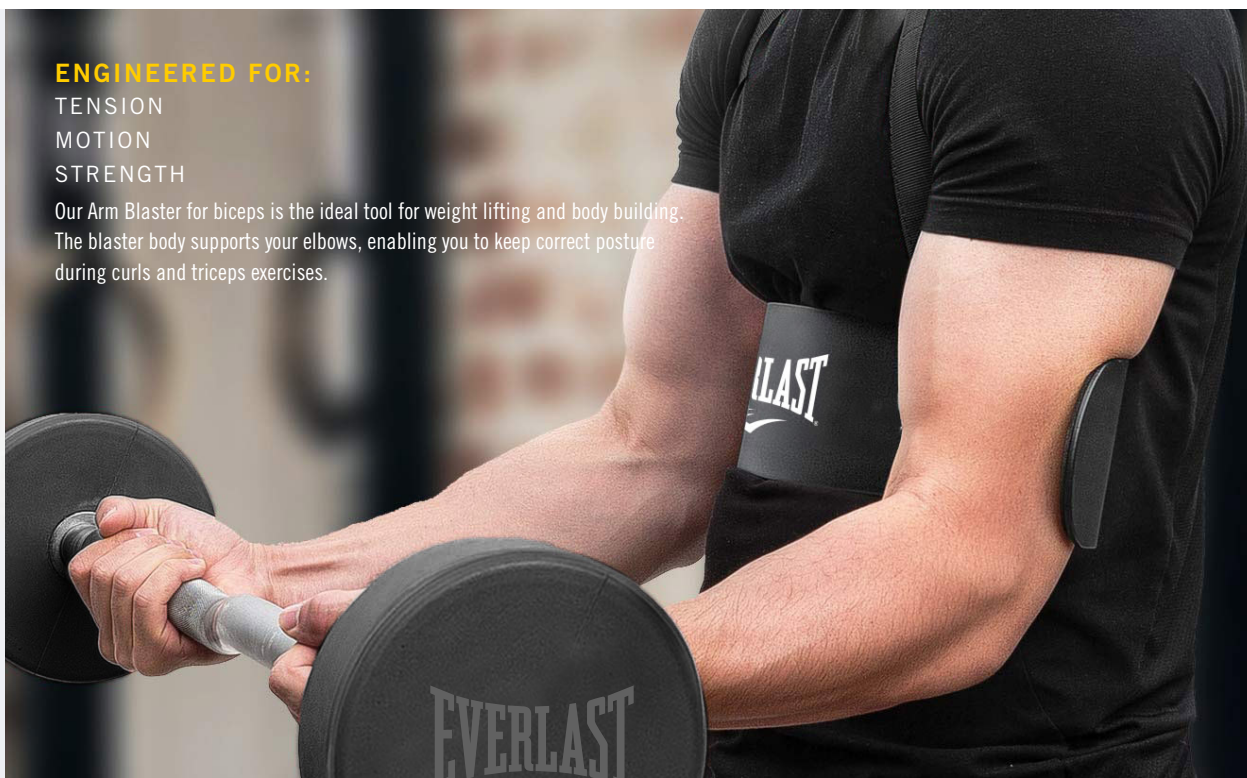



KETTLEBELL DLX

A training plan with kettlebell is suitable for all who want to vary your training fitness and force. Everlast kettlebells are available in the weight increments you need from lightweight Beginner bells starting at 4kg / 9lb to 32kg / 70lb. Color-coded handles for easy recognition. Texture matters. A well formed, balanced, and properly textured kettlebell feels better in the hand and performs better in motion.

- SKU: EVIK8R009 COLOR: White 4kg / 9lb
- SKU: EVIK8R018 COLOR: Pink 8kg / 18lb
- SKU: EVIK8R026 COLOR: Blue 12kg / 26lb
- SKU: EVIK8R035 COLOR: Yellow 16kg / 35lb
- SKU: EVIK8R044 COLOR: Grey 20kg / 44lb
- SKU: EVIK8R053 COLOR: Green 24kg / 53lb
- SKU: EVIK8R070 COLOR: Red 32kg / 70lb



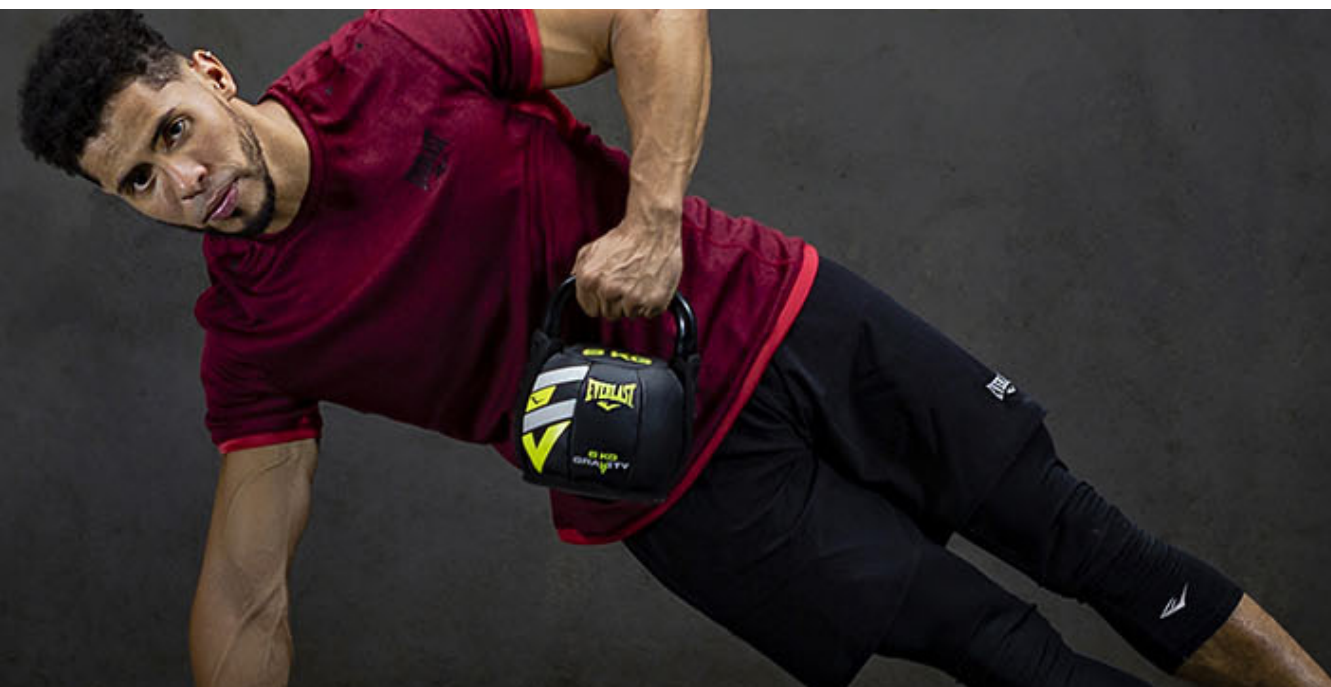

SOFT KETTLEBELL

Heavy Duty Stitching For Extra Strength And Durability.
High Density Stuffing To Keep Weight Centered During Use.
Flat Bottom.

Handles Are Easy To Grip And Will Hold Chalk.
Soft Material And Stuffing Provides Safety During
Workouts And Protects Flooring.

SKU: EVSK7R06 **6Kg** **COLOR:** Black / Yellow

SKU: EVSK7R10 **10Kg** **COLOR:** Black / Blue

SKU: EVSK7R14 **14Kg** **COLOR:** Black / Red

SKU: EVSK7R16 **16Kg** **COLOR:** Black / Orange

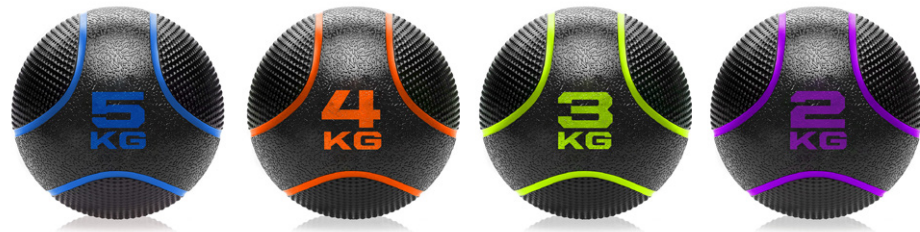

MEDICINE BALL

Medicine Balls Are The Perfect Exercise Tool For All Fitness, Cross Training, Boxing And Gym Work. Build Your Resistance Levels, Endurance And Strength.

- SKU: EVRM0W06 **6KG COLOR:** Black / Red
- SKU: EVRM0W05 **5KG COLOR:** Black / Blue
- SKU: EVRM0W04 **4KG COLOR:** Black / Orange
- SKU: EVRM0W03 **3KG COLOR:** Black / Lime
- SKU: EVRM0W02 **2KG COLOR:** Black / Purple

POWERCORE BAG MEDICINE BALL

Medicine ball is a great tool for a complete body workout and ideal for building muscle. It can be used for a range of applications such as gymnastics, general fitness, increasing stamina and therapeutic applications in physical rehabilitation programs.

- SKU: EV3085 **5kg COLOR:** Black
- SKU: EV3086 **4kg COLOR:** Black
- SKU: EV3087 **3kg COLOR:** Black
- SKU: EV3088 **2kg COLOR:** Black
- SKU: EV3089 **1kg COLOR:** Black



POWERCORE BAG MEDICINE BALL

Textured panels ensure a secure grip for safety and stability. While exercising.
Center placed sand chamber provides balance and rotation. Perfect addition to any core workout. Synthetic leather. Available in 9lbs and 12 lbs.

SKU: 6512 9lbs COLOR: Black

SKU: 6513 12lbs COLOR: Black



WALL BALL (10lb 14lb 20lb 30lb)

CARBON FIBER FABRIC

Balls are ideal for rotational movements, core exercises of many types and dynamic strength training all while the ball remains dimensionally stable and balanced and moisture and scuff resistant.

Soft shell, heavy duty vinyl coated nylon construction design holds its shape over time and allows you to strike balls with arms and legs for more diverse training.

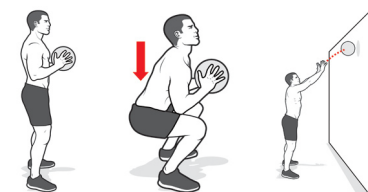

SKU: EVWL7R010 10lbs COLOR: Black / Orange

SKU: EVWL7R014 14lbs COLOR: Black / Green

SKU: EVWL7R020 20lbs COLOR: Black / Blue

SKU: EVWL7R030 30lbs COLOR: Black

A close-up photograph of a person's hands holding a blue and black medicine ball. The ball is oval-shaped with a textured black mesh on the ends and a smooth blue surface in the middle. The word "EVERLAST" is printed in white, stylized, bold letters across the top blue section, with a white winged logo underneath. Below the logo, a black strap with a diamond-shaped stitching pattern is visible. At the bottom of the blue section, the weight "20lbs" is printed in large, white, bold letters. The person's hands are positioned on either side of the ball, and their forearms are visible. The background is a blurred outdoor setting with a concrete floor.

EVERLAST

20lbs

H.I.T. HIGH INTENSITY TRAINING



POWERCORE BAGS 10KG 15KG 20KG

The power bag from everlast is a versatile training tool to develop strength and cardiovascular fitness.

THE BAGS CAN ALSO BE USED IN A VARIETY OF WAYS;

Squats, walking lunges, chest press, shoulder press or explosive throw drills. alternatively lighter bags can be used with a training partner to throw, catch and move.

SKU: EVSB7S710 **10kg** **COLOR:** Red

SKU: EVSB7S715 **15kg** **COLOR:** Blue

SKU: EVSB7S720 **20kg** **COLOR:** Grey

H.I.T. HIGH INTENSITY TRAINING





AB MAT TRAINER

EVERLAST AB MAT TRAINER PROVIDES:

Offers low-back comfort and support during ab exercises.

The contoured shape promotes safe lumbar extension, placing the abdominal muscles on a pre-stretch position resulting in a maximal abdominal activation. It is the perfect complement to a mat routine, elevating the body off the floor during crunches, curls, Sit-ups, side bends and back extensions.

SKU: EVAB9W100 **COLOR:** Black



AB MAT PRO ABDOMINAL TRAINER

THE EVERLAST AB MAT PROVIDES:

The full range of motion necessary to work the entire Abdominal muscle group.

A variety of exercises that isolate upper and/or lower abs, as well as the obliques and lower back muscles.

A safe, comfortable design contoured to your lower back Which helps to prevent injury and supports your spine.

SKU: EVAB4S06 **COLOR:** Blue

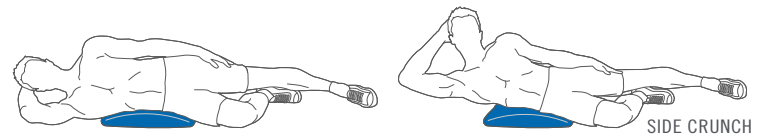



33cm MASSAGE ROLLER

Excellent for soothing muscle pains, balance exercises, and strength conditioning. Use your own body weight to help increase blood flow and circulation to the soft tissues Improve springiness, range of motion, minimize pain and soreness

FEATURES AND SPECIFICATIONS

Molded polyethylene foam technology Smooth and semi-firm surface that will not loose its shape after multiple uses

NEW

**33
cm**

SKU: EVRL9W330 **COLOR:** Black / Red



FOAM ROLLER

Excellent for soothing muscle pains, balance exercises, and strength conditioning. Use your own body weight to help increase blood flow and circulation to the soft tissues Improve springiness, range of motion, minimize Pain and soreness

FEATURES AND SPECIFICATIONS

Molded polyethylene foam technology Smooth and semi-firm surface that will not loose Its shape after multiple uses

SKU: EVFR4I036 36" **COLOR:** Black

SKU: EVFR4I024 24" **COLOR:** Black

SKU: EVFR4I012 12" **COLOR:** Black



WEIGHTED TRAINING VESTS

Adjustable straps for a snug fit during exercises.
Made with soft neoprene material for ultimate Comfort & durability.
Ideal for strength and weight training, weight loss and improving bone density.
One size fits most body types.

REFLECTIVE TAPES

There are multi reflective tapes on both sides of the weight vest which make the night running much safer.

NEOPRENE MATERIAL

Made with soft breathable neoprene fabric with quality sand filling, which is super soft and helps to concentrate the weight in the chest and upper body during training and builds core muscle strength.

EVENLY DISTRIBUTED WEIGHTS

Extra resistance evenly to body weights, it will not slip and slide during any activities.

CONVENIENT STORAGE POCKET

Mesh pocket to store belongings on the back of the weight vest when running or walking.

SKU: EVVV0W610 10Lbs COLOR: Grey
SKU: EVVV0W620 20Lbs COLOR: Black



10LB



20LB

PROVIDE ADDITIONAL WRIST SUPPORT ANYTIME YOU NEED IT.



WEIGHTLIFTING WRIST WRAPS

Wrist Wraps provide additional wrist support anytime you need it. Rubber closure for easy, custom tightening. Made from a cotton, elastic, and polyester blend that absorbs excess moisture and won't irritate the skin.

SKU: EVWR7R527 COLOR: Black

ENGINEERED FOR:
PROVIDE WRIST SUPPORT FOR BOTH MEN AND WOMEN AND CAN BE USED IN A WIDE VARIETY OF SPORTS AND FITNESS ACTIVITIES

ONE PAIR
LENGTH 20"

NEW

HIGH PERFORMANCE KNEE WRAPS

Made of heavy duty elastic, 78" inches long / 3" wide. Knee wraps provide therapy and compression for the knee. Cold pack therapy is recommended for optimum recovery Of acute knee injuries.

Wear during intense training to help prevent injuries. One size fits all, sold as a pair.

SKU: EVKW9H752 COLOR: Black / Red

ENGINEERED FOR:
PROVIDE IMMENSE SUPPORT, STABILITY AND PROTECTION OF YOUR KNEES DESIGNED TO ADJUST TO YOUR MOVEMENTS WITH A HIGH-PERFORMANCE STRETCHABLE FABRIC, THE LIFTING WRAPS WEIGHTLIFTING SUPPORT BRACES ARE SURE TO OFFER YOU TOP-NOTCH STRETCHING WHICH FEELS EXTREMELY NATURAL.

ONE PAIR
LENGTH 78"





LIFTING STRAPS

Removes Pressure From Hands To Allow For Greater Lifting Ability.
Provides Greater Lift With A Padded, Comfortable Hold On The Bar
Durable 100% Cotton Webbing

ONE SIZE FITS ALL

ENGINEERED FOR:
SUPERIOR HAND PROTECTION DURING WEIGHTLIFTING

SKU: EVCS1S20 **COLOR:** Black



PRO GRIP WEIGHT LIFTING COTTON STRAPS

Grip flex technology adds extra cushioning and flexibility. Around the wrist during heavy lifting.
Strap is made from heavy duty cotton and flex rubber for added strength and a "no-slip" grip
When using the strap, rubber side must always face bar
20.5" extended length allows you to wrap the bar several times
1.5" inches wide

ONE PAIR
LENGTH 20.5"
1.5" IN WIDE

ENGINEERED FOR:
SUPERIOR HAND PROTECTION DURING WEIGHTLIFTING

SKU: EVCS4H706 **COLOR:** Black



PRO WEIGHT LIFTING HOOKS

Designed To Enhance Grip And Reduce Finger Fatigues.
Neoprene Wrist Pad Cushions Keeps Wrist In Proper Position To Help Prevent Hyper Extension.
Ballistic Grade Nylon Increase Durability, Fully Adjustable Closure.
Sold As Pairs.

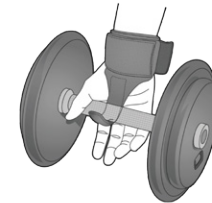

ONE SIZE FITS ALL

ENGINEERED FOR:
SPECIALLY DESIGNED FOR HIGH INTENSITY TRAINING WORKOUTS

SKU: EVHK4H705 **COLOR:** Black



SPORTS CHALK **300g**

MAGNESIUM CARBONATE

Ideal for Gymnastics, Weight lifting and High Intensity Training.

Enhance the grip on all sort of bars and sports equipment.

Designed to reduce hand moisture for better traction

Helps prevent your hands from slipping on the barbell or rings

SKU: EVCK9R300



CONTOURED WEIGHT LIFTING BELT

Used during weightlifting activities.
Expanded back support & more comfort with less irritation.
Snug fit adds support and encourages proper form.
Created for comfort and flexibility, provides exceptional support for the back.
Encourages correct form throughout weight lifting routines.

SKU: EVSB4S39-SM COLOR: Black **S / M** FITS WAIST SIZES 24"/34".
SKU: EVSB4S39-ML COLOR: Black **M / L** FITS WAIST SIZES 34"/48".



UNIVERSAL WEIGHT LIFTING BELT

4"/6" WIDE WATERPROOF FOAM CORE BELT IS HAND WASHABLE, AIR DRY
One Adjustable Size.
Maximum lower back and abdominal support for heavier lifts!
Strong and durable.
This contoured belt helps you achieve killer results.
Safely and comfortably.

SKU: EVUB084 COLOR: Black **4"**
SKU: EVUB086 COLOR: Black **6"**



4" LEATHER WEIGHT BELT

Interior foam cushioning and suede lining for enhanced comfort.
Heavy duty dual pronged steel roller buckle secures tensioning.
Supports your lower back during those heavy brutal lifts.

NEW

ENGINEERED FOR:
SUPPORT
STABILITY
POWER

SKU: EVLB9H440 COLOR: Black

S M L XL

H.I.T. HIGH INTENSITY TRAINING

HOW TO WEAR

POSITION LEATHER PALM GRIPS ON FRONT OF HAND SO BUCKLE IS UNDER THUMB, AND FLAP ROLLS AROUND OUTER EDGE OF PALM. USE A FEW TIMES TO DETERMINE WHERE YOU WANT FLAP POSITIONED ON FINGERS. TRIM FLAP TO DESIRED LENGTH WITH SCISSORS.

HOW TO USE

LEATHER PALM GRIPS WORK EVEN BETTER WITH A LITTLE SWEAT AND CHALK!

FAST ON OFF FOLD FLAT ON PALM TO USE FOLD BACK ON WRIST TO CLEAR EXCLUSIVE LEATHER GRIP PROTECTS AGAINST CALLUSES AND SKIN TEARING DESIGNED FOR RIGHT AND LEFT WITH QUICK RELEASE SIZED FOR BEST FIT AND GRIP COVERAGE

DESIGNED FOR RIGHT AND LEFT WITH QUICK ON/OFF RELEASE

LEATHER PALM GRIPS

Quick-release, Wrap-around, Fingerless Design
Personally Customizable Grip Size
(Trim To Match Your Finger Length)
Leather Grip To Protect Hands
Designed For Use With Right Or Left Hand
Grip Folds Flat On Palm For Use And Folds
Back On Wrist To Clear

SKU: EVPP6H001 **COLOR:** Charcoal



Along with protecting your hands from the cuts and calluses that can come with high-rep workouts, pull-up grips offer some unique innovations in convenience and customization.



Each grip gives the user the chance to personally trim the finger length using a simple pair of scissors to match their own hand size.



When worn, the protective leather grip can then either fold flat on the palm (When you need it) or fold back over the wrist strap to free up your hands again as needed.



PALM PROTECTOR

Superior hand protection during weightlifting.
Superior Grip.
Flexible and durable rubber material.

HOW TO USE

Slip fingers into the loops with the curved edge facing your thumb. Securely grip the bar and begin your training session.

**ONE
SIZE
FITS ALL**

ENGINEERED FOR:
SUPERIOR HAND PROTECTION
DURING WEIGHTLIFTING

SKU: EVPP7H094 **COLOR:** Black



PALM PROTECTOR

Removes excess material from the fitness glove
Comfort-cooling solution for your hands
Radial finger loops provide fast on/off action
Optimum palm protection, positioning and grip

**ONE
SIZE
FITS ALL**

ENGINEERED FOR:
SUPERIOR HAND PROTECTION
DURING WEIGHTLIFTING

SKU: EVPP1000 **COLOR:** Black



GRIP GUARD

Ideal for exercises such as rope climbing, pull ups, olympic lifts and kettlebell workouts.
These gloves are extremely lightweight and durable.
Designed to maximize breathability while preventing moisture.
Gripper gloves are a good choice for anyone who wants to improve grip during training workouts.

FEATURING
EVERCOOL™
TECHNOLOGY

ENGINEERED FOR:
SPECIALLY DESIGNED
FOR HIGH INTENSITY
TRAINING WORKOUTS

SKU: EVWG5H444 **COLOR:** Black

S / M - M / L

The Everlast logo, featuring the brand name in a stylized, white, serif font with a winged emblem below it, set against a dark grey square background.

HIGH INTENSITY
TRAINING



www.everlastlatam.com



[everlastlatino](https://www.instagram.com/everlastlatino)



[@everlastlatam](https://twitter.com/everlastlatam)

DEPORTIVA INTL. S.A.

An authorized licensee of Everlast worldwide inc,
Via España #14 Edificio Deportes Jimmy, Panamá

T (507) 300.3075 / F (507) 300.3082